

Talk



Talk (Design: Jehs + Laub)

Talk öffnet neue Perspektiven. Ein intelligentes Tischsystem für flexible sowie für feststehende Konferenztische, für Tagungen, Besprechungen und Seminare. Kurz: für alle Kommunikationsbereiche eines Unternehmens. Talk vereint in sich wesentliche funktionale Aspekte. Sein modularer Aufbau gestattet es, unterschiedliche Plattengrößen und -formen miteinander zu kombinieren. Von Einzeltischen bis hin zu ovalen, runden und rechtwinkligen Tischanlagen. Doch lohnt bei Talk auch der Blick unter die Tischplatte: Der verchromte, leicht und elegant gestaltete Aluminiumfuß garantiert nicht nur Stabilität und maximale Beinfreiheit, bei Tischanlagen übernimmt er auch die Aufgabe als patentiertes Verbindungselement zwischen zwei Platten. Zwei formschöne Hebel arretieren die Tischbeine an der Platte. Die einfache und schnelle Montage und Demontage erfolgt werkzeuglos. Zur Kabelführung dienen horizontale Kanäle. Vertikale Kabelabdeckungen können an jedem Tischbein nachträglich aufgesteckt werden.



Talk (Design: Jehs + Laub)

Talk opens up new prospects. An intelligent table system for both flexible and fixed arrangements for conferences, meetings, and seminars. In short, for all a company's communication needs. Talk integrates key functional features. The modular construction makes it easy to combine different table sizes and forms, from single tables to oval, round and rectangular arrangements. But Talk makes it worth taking a look under the table, too. The light and elegantly designed chrome-plated aluminium base not only guarantees stability and maximum legroom, but also serves to ingeniously connect adjoining tabletops. Two levers discreetly lock the legs to the tabletop. Assembling and disassembling the units is quick and easy, and no tools are required. Horizontal channels accommodate cables. All table legs can be retrofitted with vertical cable covers.





Talk | Haus des Landtags, Stuttgart

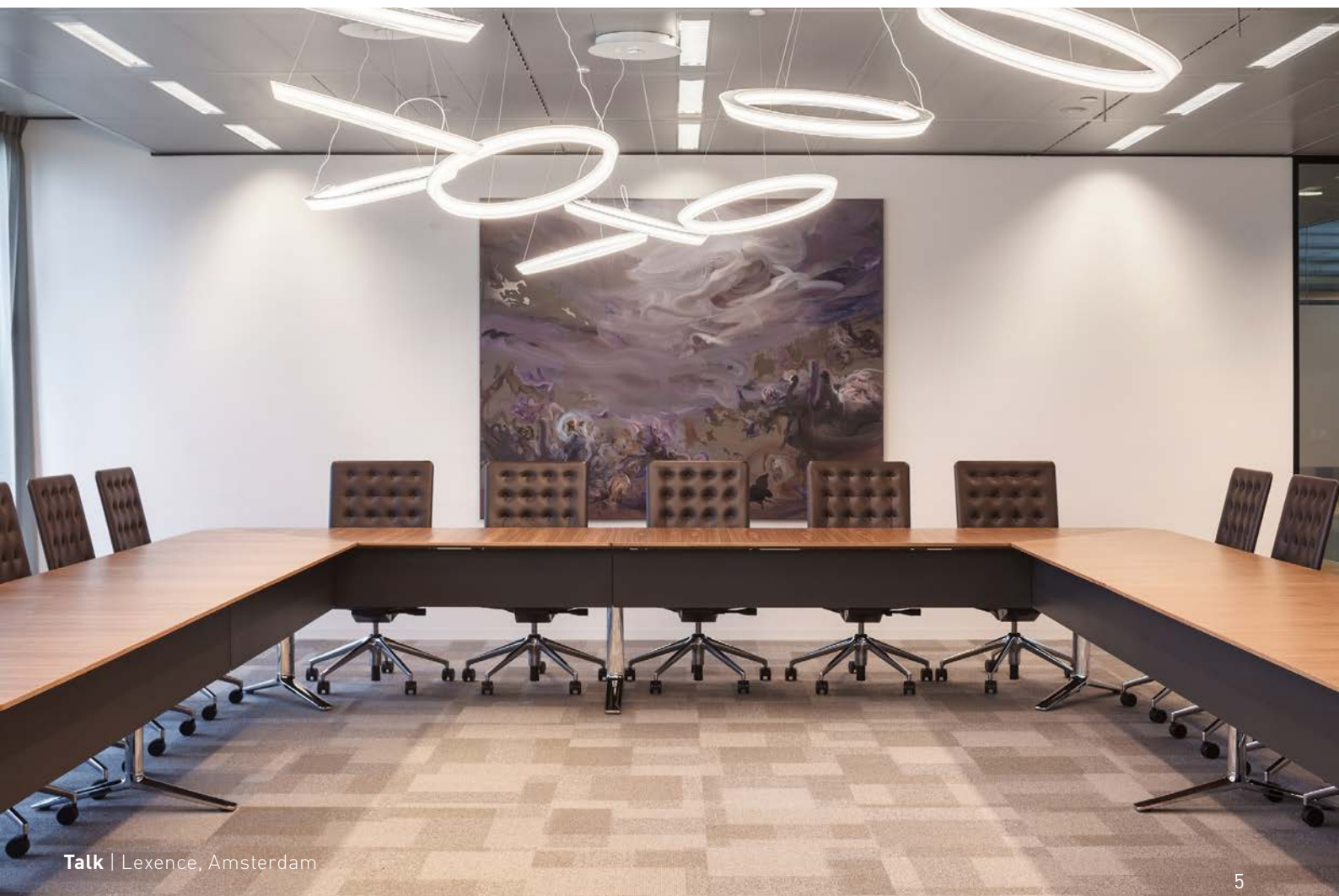





Talk | Rathaus, Maastricht

Der verchromte leicht und elegant gestaltete Aluminiumfuß garantiert Stabilität und maximale Beinfreiheit.

The unobtrusive, elegantly formed chrome-plated aluminium leg ensures stability and maximum legroom.



Der Deckel der Elektrobox kann wahlweise in der Ausführung der Tischplatte - furniert - in Strukturlack oder Laminat - gewählt werden.

The lid of the power box is available in structured lacquer or laminate to match the tabletop.



Der großvolumige Kabelkanal ist abklappbar und kann werkzeuggesteigert montiert und demontiert werden.

The spacious cable channel is removable and can be mounted and dismantled without tools.



Der Tischfuß kann am Stoß zweier Platten als patentes Verbindungselement oder eingerückt positioniert werden. Die Befestigung erfolgt über 2 Hebel, die werkzeuglos bedient werden.

The table leg can be positioned as an ingenious connecting element at the junction of two tabletops or recessed. Two levers lock the base to the tabletop without the use of tools.



Mobil, einfach und sicher. Die Transportwagen der Talk Konferenztischanlagen für Tischplatten oder für Tischfüße zeichnen sich durch hohe Stabilität aus. Sie sind mit Lenkrollen ausgestattet, 2 davon mit Feststellbremse.

Portable, simple and secure. The Talk transport trolleys for tabletops or legs are extremely stable. Two of the four swivel casters have a locking brake.

Die Sichtblende aus anthrazit beschichtetem Stahlblech wird werkzeuglos eingehängt.

The modesty panel of anthracite-coloured powder-coated sheet steel can be installed without tools.



Rechteckige Tischplatten. Rectangle table tops.

Abschlussplatten. End tops.



160 x 85
Höhe height 73



220 x 85
Höhe height 73



180 x 85
Höhe height 73



240 x 85
Höhe height 73

Viertelkreis Tischplatten. Quarter circle table tops.

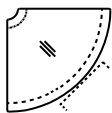

Radius 95 x 85
Höhe height 73

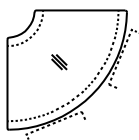

Radius 110 x 85
Höhe height 73

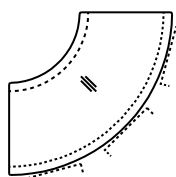

Radius 150 x 85
Höhe height 73

Eckplatten. Corner tops.

Kopfplatten. Head tops.

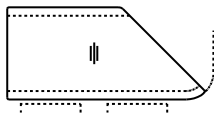

190 x 85
Höhe height 73



250 x 85
Höhe height 73

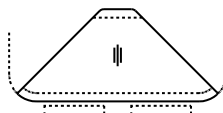

200 x 85
Höhe height 73

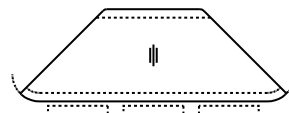

260 x 85
Höhe height 73

Tischfuß. Table leg.

Vertikale Kabelführung. Vertical cabling element.

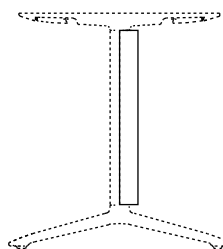
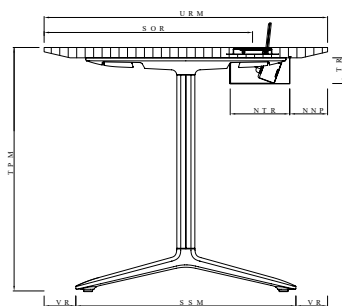

Beispielhafte Konferenztischkonfigurationen. Exemplary conference table configurations.

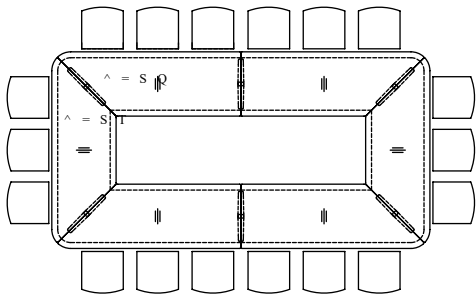

500 x 260
Höhe height 73

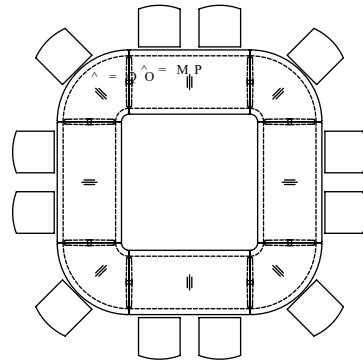

350 x 350
Höhe height 73

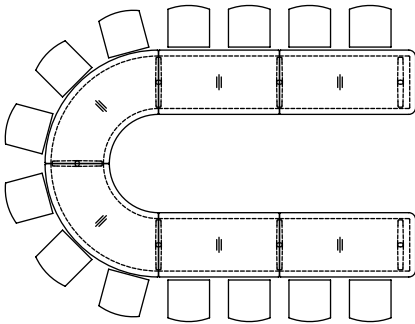

490 x 300
Höhe height 73

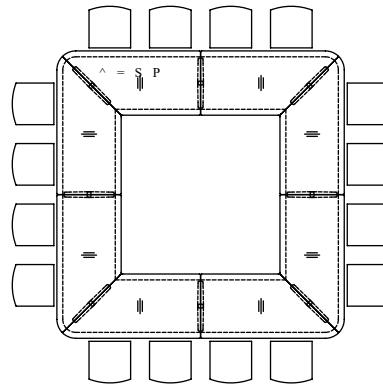

380 x 380
Höhe height 73

Transportwagen. Transport trolley.

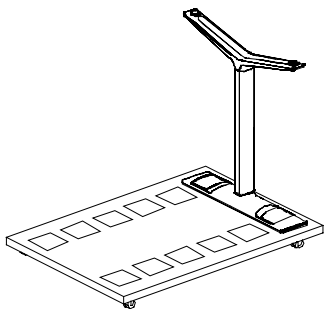

für max. 6 Tischfüße
for max. 6 table legs

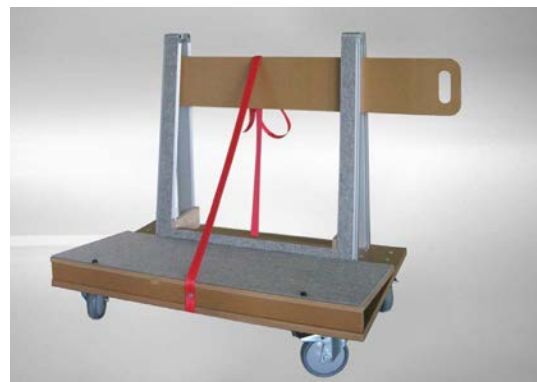

für max. 6 Tischplatten, Kabelkanäle und Sichtblenden
for max. 6 table tops, cable conduits and modesty panels

Talk

Besprechungs- und Konferenztische/Meeting and Conference tables

Talk ist ein flexibles Konferenztischprogramm. Die unterschiedlichen Tische können ohne Werkzeug einfach und schnell auf-, ab- und umgebaut werden. So wird aus der großen Konferenztischanlage (1), eine Seminaranordnung (2) und ein runder Besprechungstisch für bis zu 12 Personen (3). Die Vorteile liegen auf der Hand: Mehr Flexibilität und Raumeffizienz. Tischplatten und Tischfüße lassen sich auf separaten Transportwagen platzsparend transportieren und lagern.

Talk is a flexible conference table programme. The various tables can quickly and easily be assembled, reassembled and disassembled without the use of tools. The large conference table system (1) is easily converted to a seminar configuration (2) and a round conference table for up to 12 participants. The advantages are clear: more flexibility and efficient use of space. Tabletops and legs are easily transported and stored on separate transport trolleys.

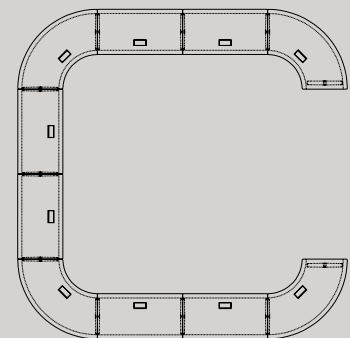
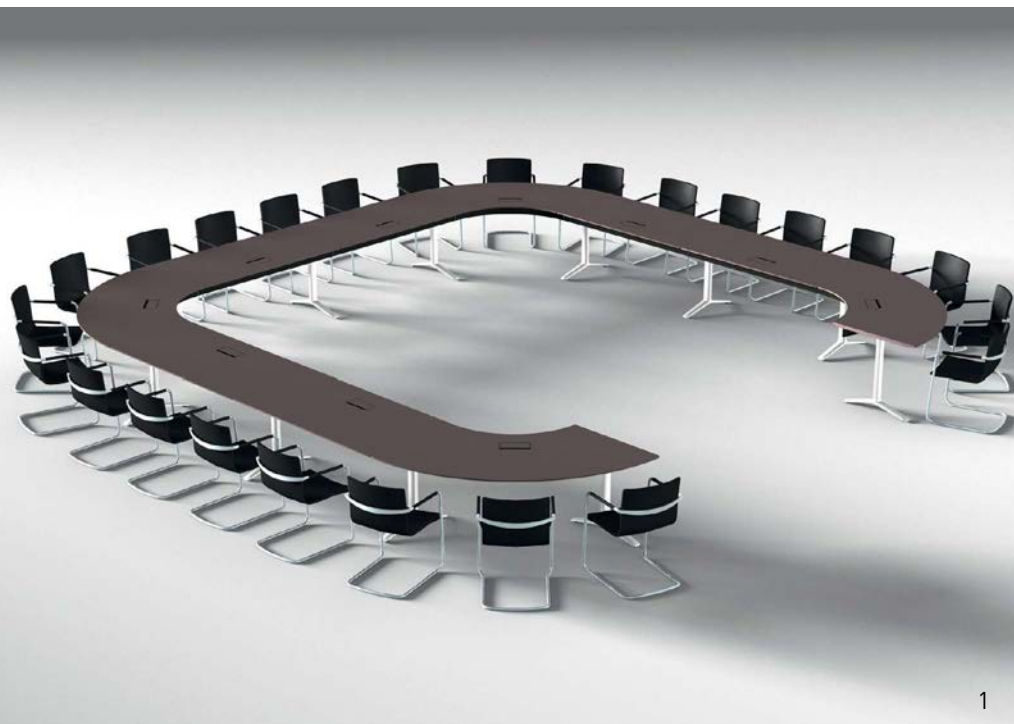

620 x 620 cm

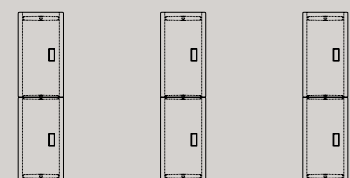

je 85 x 320 cm

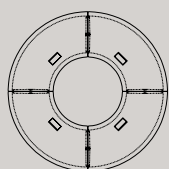

Ø 300 cm

3

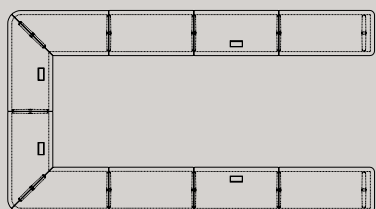
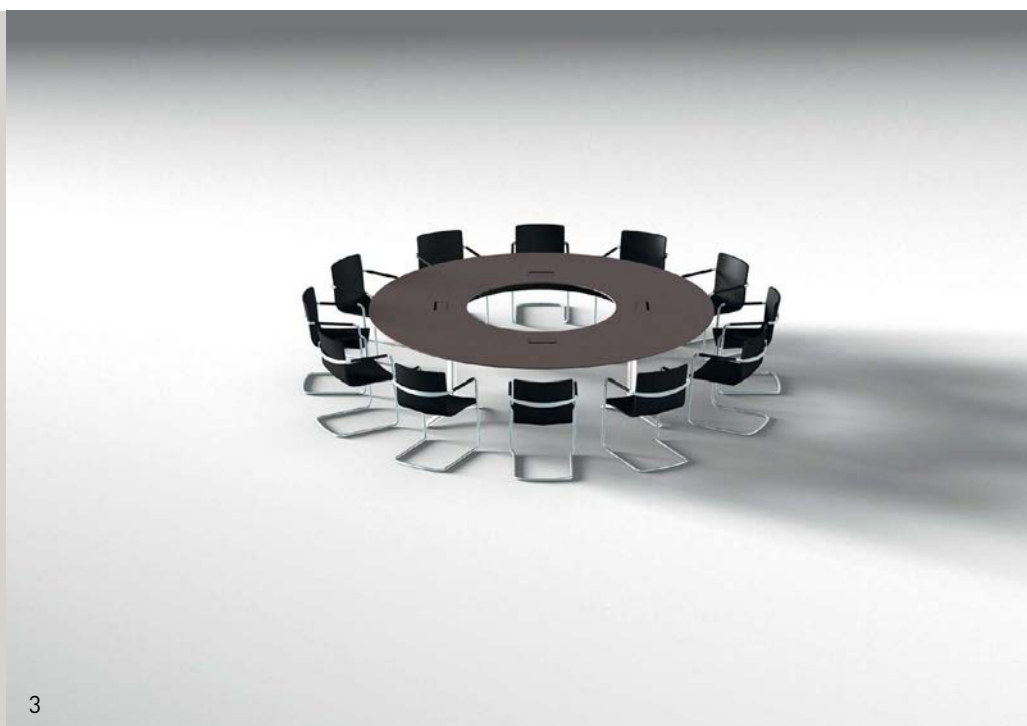

380 x 690 cm

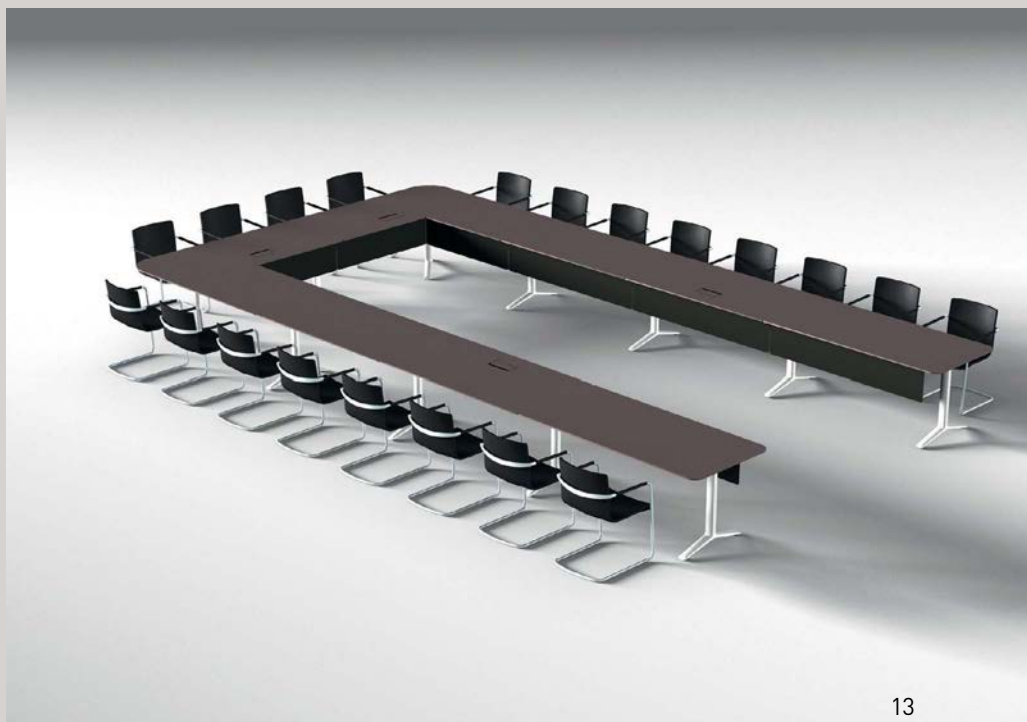

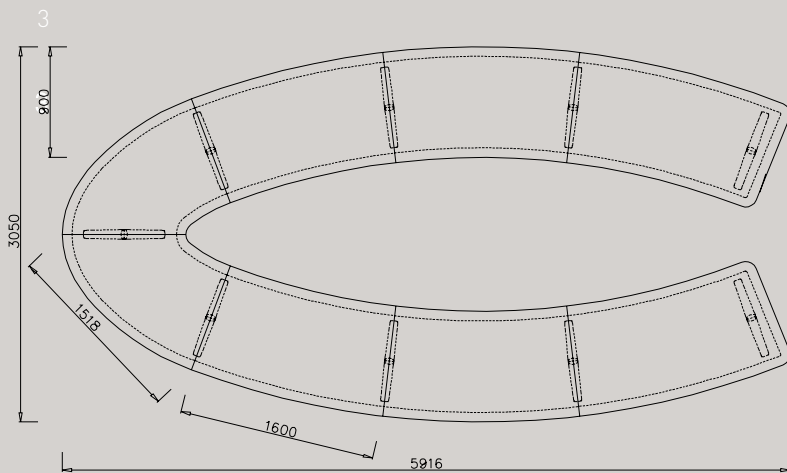
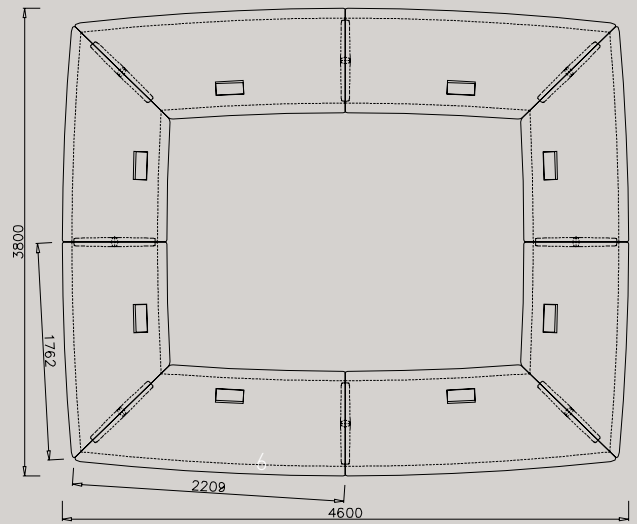
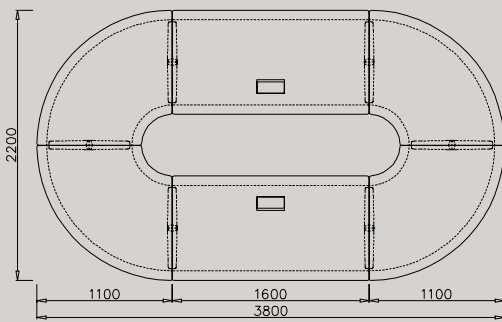
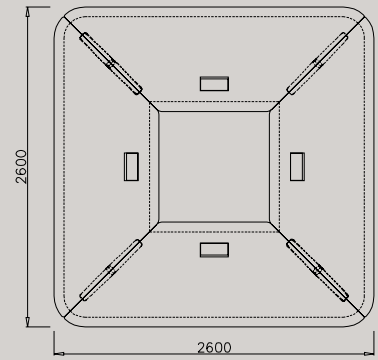
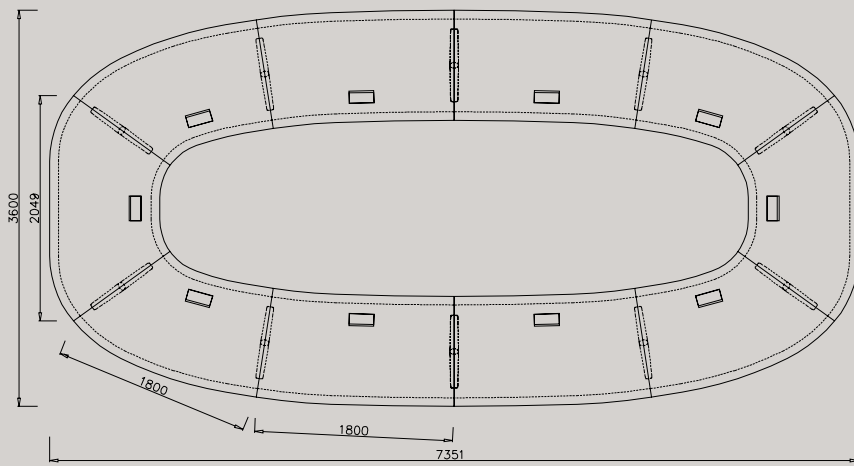

RENZ plant und fertigt Tische und Tischanlagen nach Ihren Vorgaben und Vorstellungen. Exklusive Sonderlösungen, individuell angepasst, in von der Serie abweichenden Maßen, Formen und Materialien. Sprechen Sie mit unseren erfahrenen und kompetenten Spezialisten oder mit den Fachleuten unserer ausgewählten Handelspartner.

RENZ designs and manufactures tables and table systems according to your wishes and specifications. Exclusive custom solutions to accommodate your unique needs can incorporate non-standard sizes, forms and materials. Talk to our competent, experienced specialists or to the experts at our selected partner firms.

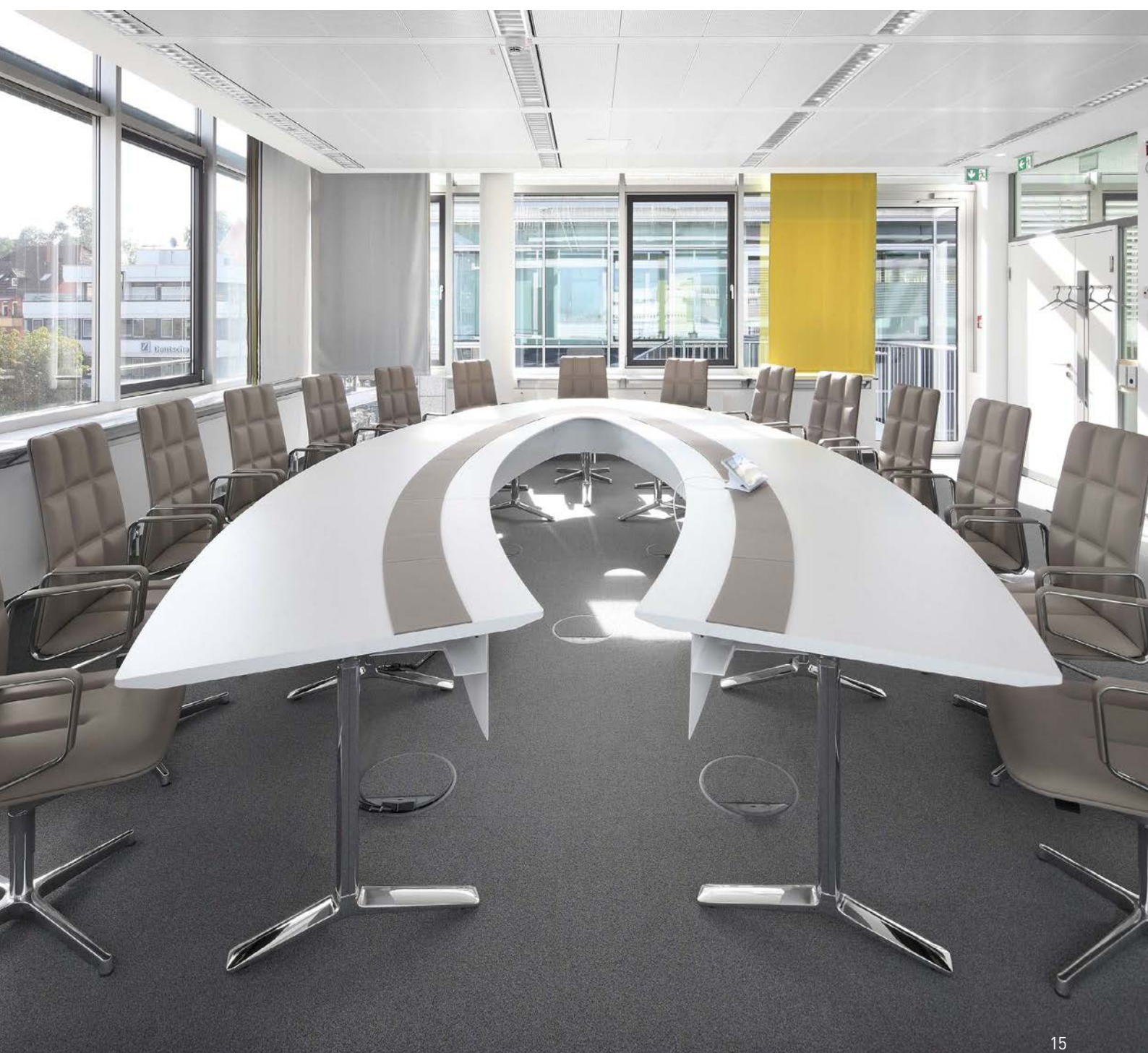



Birnbbaum natur
Pear natural



Am. Kirschbaum natur
Am. Cherry natural



Eiche matt
Oak matt



Eiche hell
Oak light



Eiche urban grey
Oak urban grey



Räuchereiche
Smoked Oak



Eiche titangrau
Oak grey titan



Eiche mocca
Oak mocca



Am. Nussbaum natur
Am. Walnut natural



Nussbaum tabac
Walnut tobacco



Zebrano natur
Zebrano natural



Zebrano grau
Zebrano grey



Eiche schwarz
Oak black



Laminat Nano weiß
Laminate nano white



Laminat Nano stone
Laminate nano stone



Laminat Nano schwarz
Laminate nano black

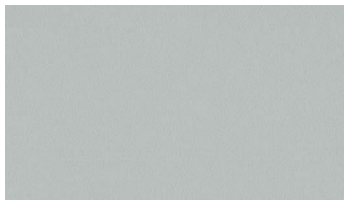

Laminat grau
Laminate grey

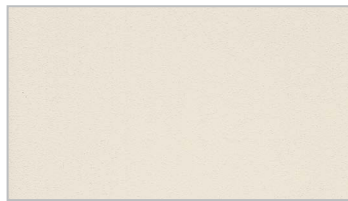

Lack Struktur weiß
Lacquer structure white

Die abgebildeten Farben sind nicht farbverbindlich. Die Darstellung kann je nach Monitor und Drucker variieren. Weitere Oberflächenausführungen wie Furniere, Laminare und Linoleum nach Muster auf Anfrage.
The colours shown are intended as a guideline only. Their representation may vary depending on the monitor and printer. Further surface finishes such as natural wood veneer, laminate and linoleum on request by sample.

Wilhelm Renz GmbH + Co. KG
Hanns-Klemm-Straße 35
71034 Böblingen
Germany

T +49 (0)7031.21880
F +49 (0)7031.218850

info@renz.de
www.renz.de

