

KEYPIECE COMMUNICATION DESK. Design: EOOS.



Keypiece supports contemporary leadership. Whether concentrated working or intense discussions in a group – the Communication Desk promotes the working methods of the modern world. Working, consulting, meeting, video conferencing – the design meets the demands. Close and confidential side by side, in discussion when opposite each other - the conical shape of the desk top makes it possible to balance proximity and distance. The turntable on top closes the cable tank and makes it possible to turn the presentation screen. There is plenty of space for PC equipment and the tools of our individual daily routines in the containers - choose from the two different versions.

Product description

Desks, conference tables

Modell no.

4500

Table top and edge versions

There are two types of edge available.

Advanced:

MDF core with chamfered edge.

Thickness: 28 mm chamfered to 10mm.

Chamfered edge painted.

Surfaces: fine textured paint, paint black with soft finish no. .04s, paint white no. .03, HPL laminate, fenix®, linoleum, linoleum black with silver-coloured edge no. .71 and veneers from price groups II, IV, V, VI.



28 mm

Soft:

MDF table top with a gently flowing edge.

Tabletop thickness: 28 mm. Chamfered

edge, painted, with integrated edge protection.

Surfaces: Only available in fine textured paint.



28 mm

Table legs and base

Table base consisting of:

- beam: aluminium profile extrusion

- joint: die-cast aluminium

- horizontal cable duct

beams, joints, cable ducts and synthetic duct covers are always black-grey.

Legs:

Aluminium leg with integrated cable duct and synthetic cover.

Legs highly-polished or coated in bronze.

Panel leg:

The trapezoidal extension tables are also available with a panel leg as an option. There is a channel integrated in the panel leg to accommodate cables. The colour from the Walter Knoll fine textured paint collection must be specified when the order is placed.

KEYPIECE COMMUNICATION DESK.

Function

The extension table can be swivelled $\pm 30^\circ$ around the attachment point.

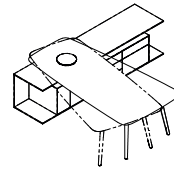

Accessories

For versions and accessories see following pages.

Pedestals

Modell no.

4540

Surfaces

Fine textured paint, paint white no. .03 or veneers from price groups II, IV, V, VI.
Corpus inside: silver grey melamine.

Versions

Two different versions of the containers are available.

Executive container:

An embrace surrounding the slide-in pedestal creates additional surfaces.

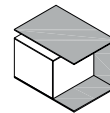

Classic container:

Traditional pedestal with top and side cover panels.

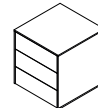

Please see the overview for more ordering instructions for the pedestals on the following pages.

Accessories

For versions, accessories and cable management see the following pages.

Doors and drawers

Doors and drawers do not have handles and open with the touch function.

Plug management

Cable routing:

All the pedestals have a hatch approximately 19 cm x 19 cm to allow access to the floor box in the bottom. However cables can also be routed through the lower ventilation slot. There are sections cut out of the sides of every pedestal so that cables can be run through to the adjacent container.

Ventilation:

All the pedestals have a 25 mm deep opening for ventilation towards the top and towards the bottom between the rear wall and the floor. It extends over the whole width of the container. Manufacturers' instructions regarding the ventilation of any devices must be taken into account.

Ordering notes

The surfaces for the relevant price groups can be found on the back pages. Please always specify the surface when ordering. E.g. 4500-A85 in wenge = 4500.85.

If you are ordering more than one desk, please specify clearly which container belongs to which desk. To ensure that a veneer is consistent over all the containers in a row, please supply a drawing with the order.

KEYPIECE COMMUNICATION DESK.

Technical drawings and dimensions

Anbautische/Extension tables →
Höhe/Height 74

4500

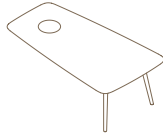

B/W 210 T/D 117

4501

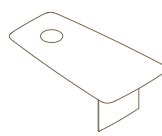

B/W 210 T/D 117

4502

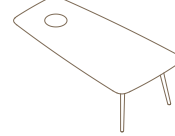

B/W 230 T/D 119

4503

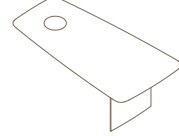

B/W 230 T/D 119

4504

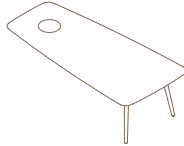

B/W 250 T/D 120

4505

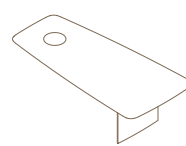

B/W 250 T/D 120

4506

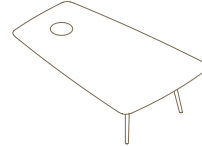

B/W 250 T/D 158

4507

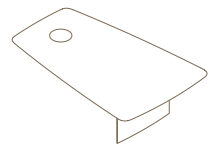

B/W 250 T/D 158

4508

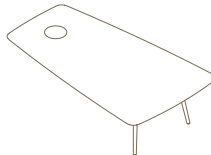

B/W 275 T/D 158

4509

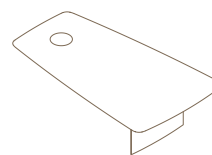

B/W 275 T/D 158

4510

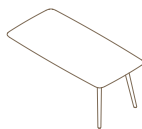

B/W 180 T/D 90

4511

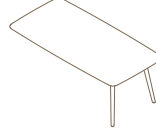

B/W 200 T/D 100

4512

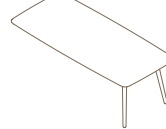

B/W 220 T/D 100

4513



B/W 240 T/D 110

Tische/Tables →
Höhe/Height 74

4514

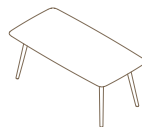

B/W 180 T/D 90

4515

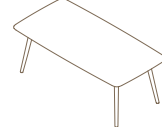

B/W 200 T/D 100

4516

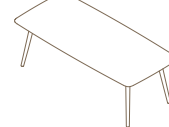

B/W 220 T/D 100

4517



B/W 240 T/D 110

4518



Ø 125

Alle Maßangaben in cm./All dimensions in cm.
B/W = Breite/width, T/D = Tiefe/depth, H = Höhe/height,
SH = Sitzhöhe/seating height, ST/SD = Sitztiefe/seating depth.

All dimensions in cm.

KEYPIECE COMMUNICATION DESK.

EXECUTIVE CONTAINER

Einschubcontainer/Insertion container →
Breite/Width 55



Einschubcontainer/Insertion container →
Breite/Width 70

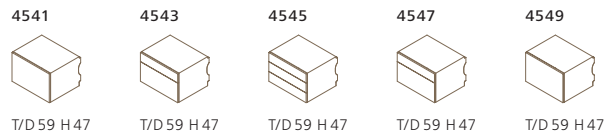

Auflagecontainer/Connecting container →

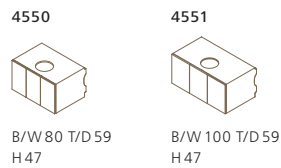

Spange für Einschubcontainer →
Embrace for insertion container
Höhe/Height 63

4530 = Container 55
4531 = Container 70
4532 = 2 Container 55
4533 = Container 55 + 70
4534 = 2 Container 70

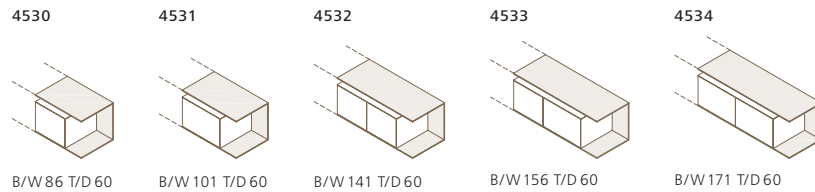

Spange für Auflagecontainer →
Embrace for connecting container
Höhe/Height 63

4535 = Container 80
4536 = Container 100
4537 = Container 80
4538 = Container 100

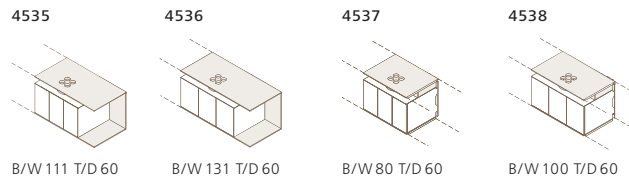

CLASSIC CONTAINER

Anbaucontainer/Extension container →
Breite/Width 55

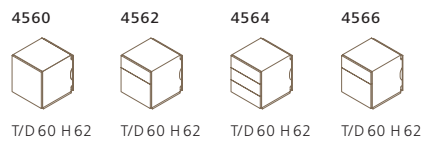

Anbaucontainer/Extension container →
Breite/Width 70

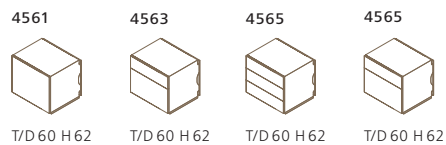

Alle Maßangaben in cm./All dimensions in cm.
B/W = Breite/width, T/D = Tiefe/depth, H = Höhe/height,
SH = Sitzhöhe/seating height, ST/SD = Sitztiefe/seating depth.

All dimensions in cm.

KEYPIECE COMMUNICATION DESK.

Sample configuration I

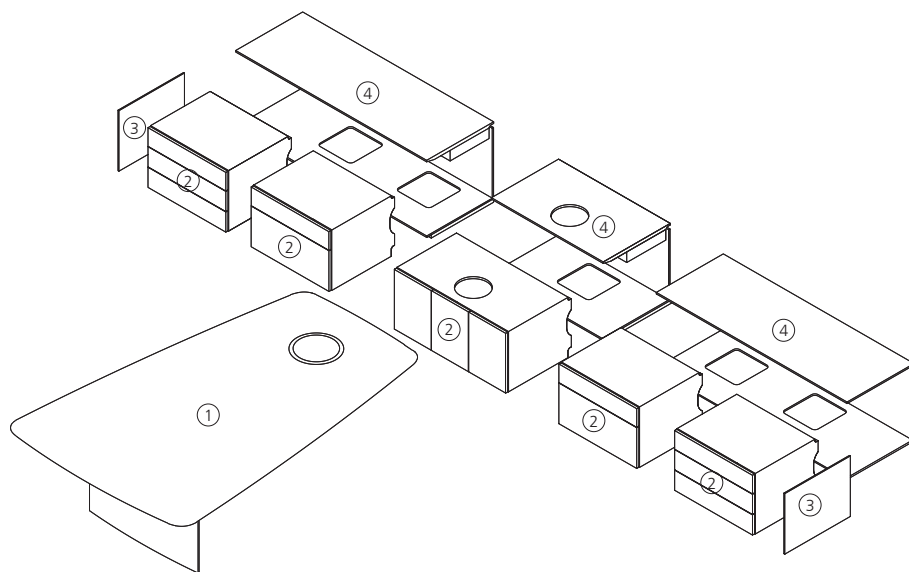

Ordering instructions for extension table with Executive Container

1. First select the extension table.
2. Then select the slide-in container you want or the appropriate supporting container for the extension table moving from left to right.
3. Then select the side cover panels model 4554.
4. Select the appropriate embraces (453x) for the pull-out pedestal configuration you have chosen. Moving from left to right.

Sample configuration II

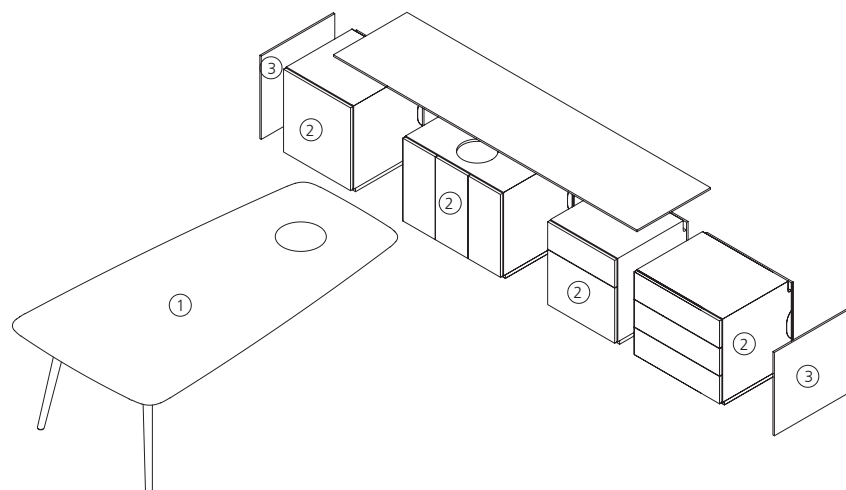

Ordering instructions for extension table with Classic Container

1. First select the extension table.
2. Then select the extension container you want or the appropriate supporting pedestal for the extension table moving from left to right
Note: the top cover panel is included in the price of the container and need not be ordered separately. Lengths of 2.75 m and above are sold separately.
3. Then select the side cover panels model 4574.